

## EKP-1, EKP+D-1

### KARE PETEK MENFEZLER PERFORATION GRILLES

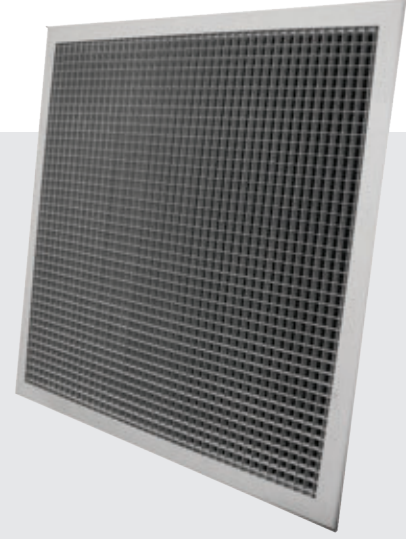

Egevent EKP-1 model menfezler havalandırma sistemlerinde emiş menfezi olarak kullanılır. Özel olarak hadde edilmiş 6063 alüminyum profilden imal edilmiştir.

Standart kaplama işlemi Ral 9010 ve 9016 renk kodlarında elektrostatik toz boyama ile yapılmaktadır, talebe göre diğer renkler ve eloksal kaplama da yapılabilmektedir.

Standartta vidalı üretilir.

*Egevent EKP-1 model perforation grilles are used as blowing and suction grilles in ventilation systems. Their frames are manufactured of specially rolled 6063 aluminum shape, their grill parts are manufactured of perforated DKP sheet.*

*Standard plating is done with electrostatic powder painting in RAL 9010 and 9016 color codes. According to the demand, other colors and anodized coating can also be done.*

*Flow control dampers can be produced form aluminum shape as opposite or parallel bladed.*

### Çerçeve Alternatifleri / Frame Variations

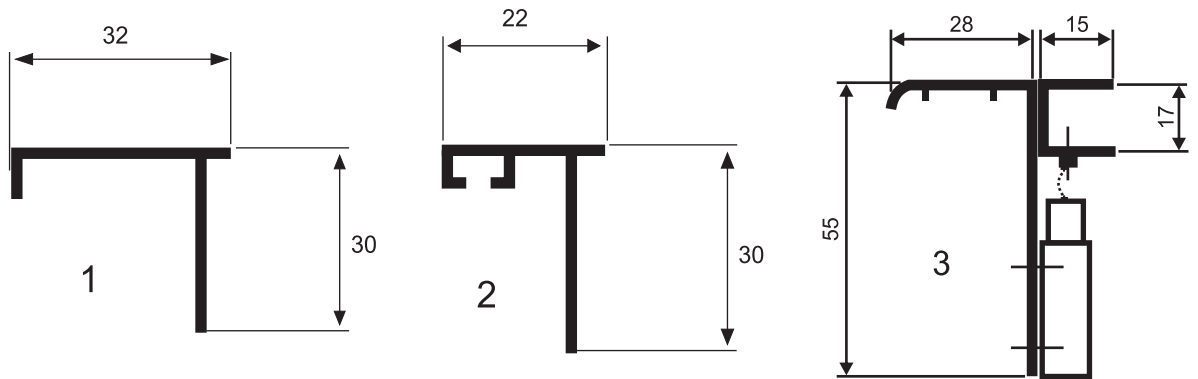

Standart çerçeve / Standart frames

## FİLTRELİ UYGULMALARDA KİLİTLEME ALTERNATİFLERİ LOCKING ALTERNATIVES IN DOUBLE FRAME MODELS WITH FILTERE

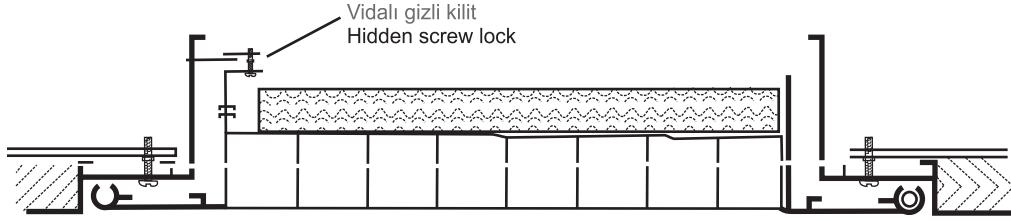

GV: Alternatif-1 / Alternative-1

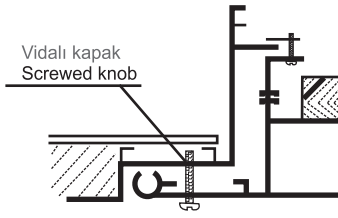

VK

Alternatif-2/Alternative-2

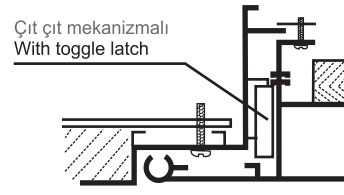

TL

Alternatif-3/Alternative-3

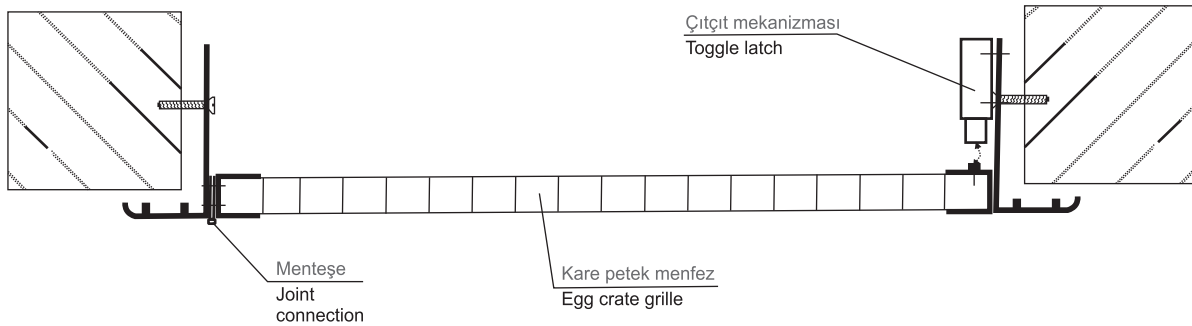

Çıtçıtlı çerçeve montaj şekli  
Assembly details of frame with toggle latch

## MONTAJ ŞEKİLLERİ / TYPES OF FIXING

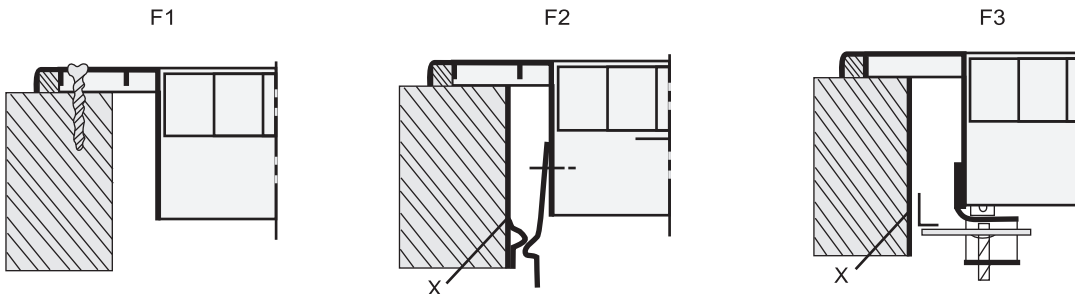

X=Kör kasa (Müşteriye aittir) / Mounting frame (Not by EGEVENT)

MENFEZLERİN EFEKTİF ALANLARI (m<sup>2</sup>) / EFFECTIVE AREAS OF GRILLES (m<sup>2</sup>)

	H mm												
	100	150	200	250	300	350	400	450	500	600	700	800	900
100	0,009	0,013	0,017	0,022	0,026	0,031	0,035	0,040	0,044	0,053	0,062	0,071	0,079
150	0,013	0,020	0,026	0,033	0,040	0,047	0,053	0,060	0,067	0,090	0,094	0,107	0,121
200	0,017	0,025	0,035	0,045	0,054	0,063	0,072	0,081	0,090	0,108	0,126	0,144	0,162
250	0,022	0,033	0,045	0,056	0,067	0,079	0,090	0,101	0,113	0,135	0,158	0,181	0,203
300	0,026	0,040	0,054	0,067	0,081	0,094	0,108	0,122	0,135	0,163	0,190	0,217	0,244
350	0,031	0,047	0,063	0,079	0,094	0,110	0,125	0,142	0,158	0,190	0,222	0,254	0,286
400	0,035	0,053	0,072	0,090	0,108	0,126	0,145	0,163	0,181	0,218	0,254	0,290	0,327
450	0,040	0,060	0,091	0,101	0,122	0,142	0,163	0,183	0,204	0,245	0,286	0,327	0,368
500	0,044	0,067	0,090	0,113	0,135	0,158	0,181	0,204	0,227	0,273	0,318	0,364	0,409
600	0,053	0,080	0,108	0,135	0,163	0,190	0,218	0,245	0,273	0,328	0,382	0,437	0,492
700	0,062	0,094	0,126	0,158	0,190	0,222	0,254	0,286	0,318	0,382	0,446	0,510	0,574
800	0,071	0,107	0,144	0,181	0,217	0,254	0,290	0,327	0,364	0,437	0,510	0,583	0,657
900	0,079	0,121	0,152	0,203	0,244	0,286	0,322	0,368	0,409	0,492	0,574	0,657	0,739
1000	0,088	0,134	0,180	0,226	0,272	0,318	0,363	0,409	0,455	0,547	0,638	0,730	0,822
1100	0,097	0,148	0,198	0,249	0,299	0,349	0,400	0,450	0,501	0,602	0,702	0,803	0,904
1200	0,105	0,161	0,216	0,271	0,326	0,381	0,436	0,491	0,546	0,657	0,766	0,877	0,987

W  
mm

SEÇİM TABLOSU  
SELECTION DIAGRAM

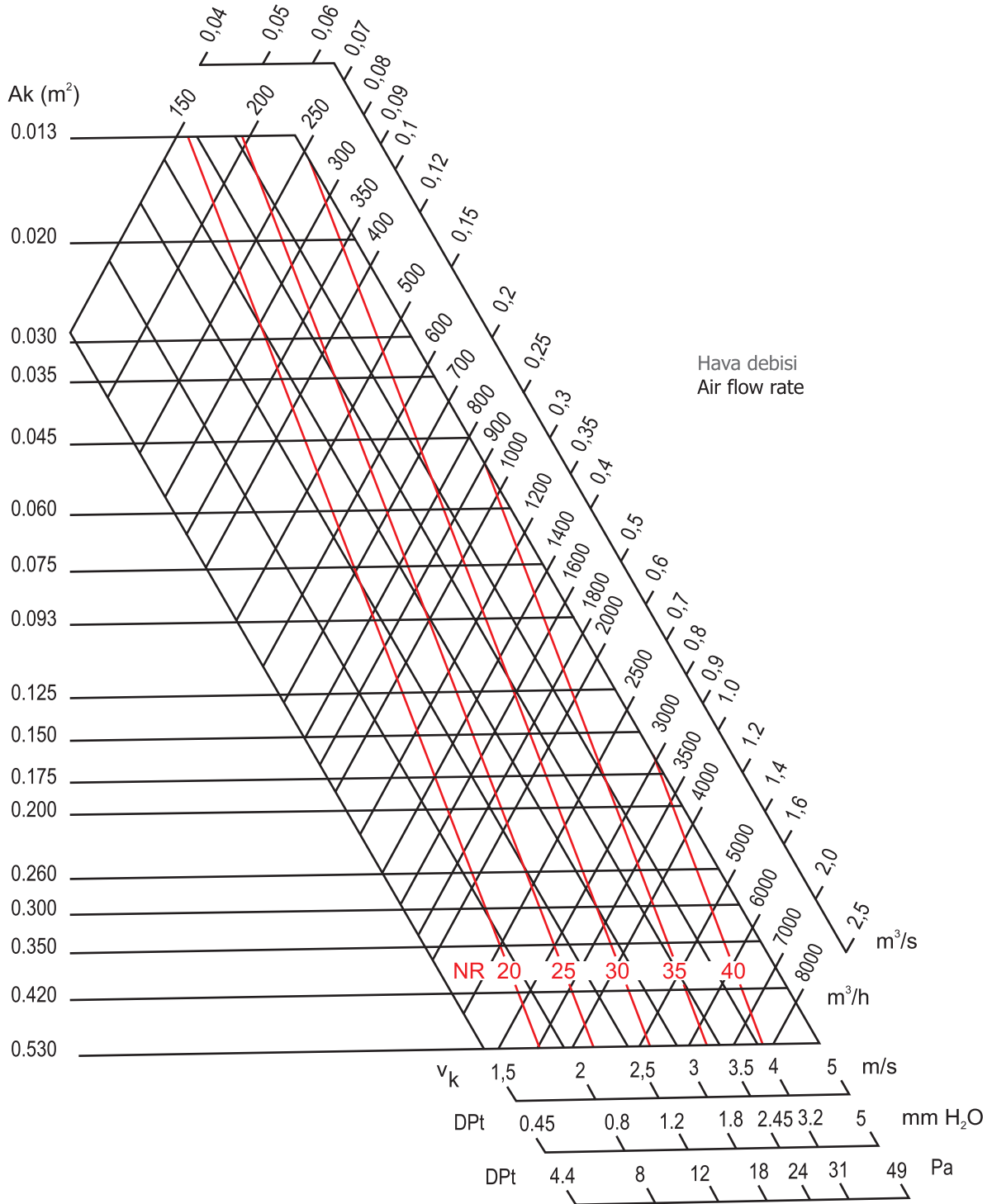

## PLENUM KUTULARAR PLENUM BOXES

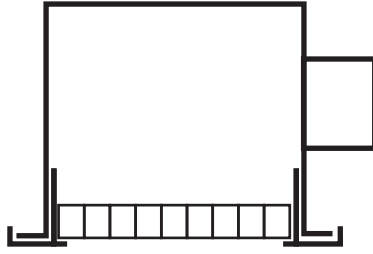

PS-I / PS-O  
Yandan giriřli  
With side entry

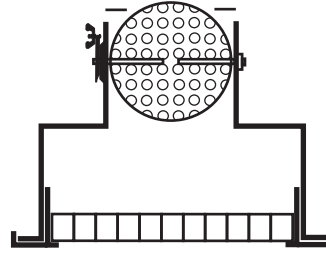

PT-I / PT-O  
Üstten giriřli  
With top entry

EKP-1 modeli kare petek menfezler istek üzerine plenum hücreli olarak da imal edilebilirler ve fabrika montajı tamamlanmış olarak gönderilebilirler. Plenum hücreler üstten giriřli ve yandan giriřli olarak iki ana tipte imal edilmektedir. Her iki tipin de damperli ve dampersiz alternatifleri mevcuttur. Damperli modellerde standart olarak elle ayar ve damper kolunu kilitleme mekanizması vardır. Fabrika montajlı iki konumlu damper motorlar ile de imal etmek mümkündür.

Plenum hücreler istek üzerine 6mm NFAF ile dış yüzeyden izole edilmektedir. Değişik bir izolasyon malzemesi istendiğinde veya akustik izole istendiğinde lütfen fabrikamıza danışın.

Plenum kutular modüler asma tavanlarda kullanılacaksa hassas imalat ölçüleri için modüler tavan taşıyıcı profillerinin sipariş ile birlikte bildirilmesi gerekmektedir.

*EKP-1 model egg-crate grilles may be manufactured with plenum boxes in accordance with the customer's demands and they may be despatched with factory installed grilles. The plenum boxes are produced in two alternatives namely with side entry and with the customer's demands. In models equipped with dampers, a manual adjustment arm and a hand locking quadrant is installed as standard. It is also possible to produce them with factory installed on-off damper actuators.*

*Whenever demanded the plenum boxes are produced with 6mm thick NFAF insulation material and thicknesses are also available upon customer's request.*

*In case they will be installed on the modular suspended ceilings, precise dimensioning of the hanger profiles must be given in order to enable precise manufacturing.*

KARE PETEK MENFEZ MODELLERİ  
DIRRERENT VERSIONS EGG-CRATE GRILLES

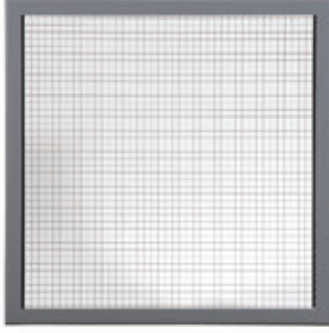

ALÇIPAN KAROLAJ ASMA TAVAN MODELİ  
MODEL SUITABLE FOR PLASTER SUSPENDED CEILINGS

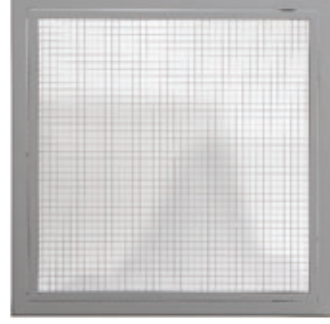

MENTEŞELİ MODEL / MODEL WITH HINGES

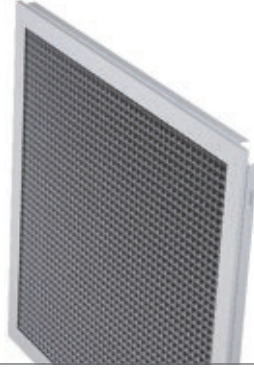

CLIP-IN MODEL / CLIP-IN MODEL

SİPARİŞ NOTASYONU  
HOW TO ORDER

**EKP-1 4da500x700GV F1 + PS-Ø 250**

